

**ERSATZTEILLISTE • SPARE PARTS LIST • LISTE DE PIÈCES DE RECHANGE
LISTINO PEZZI DI RICAMBIO • LISTA DE PIEZAS DE RECAMBIO**

BCV 300

**KLAUEN-VAKUUMPUMPEN • CLAW-VACUUM PUMPS • POMPES À VIDE A BEC
POMPE PER VUOTO A CAMME • BOMBAS DE VACÍO DE GARRA**

MAKE IT BECKER

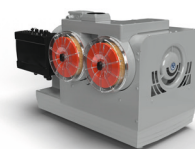
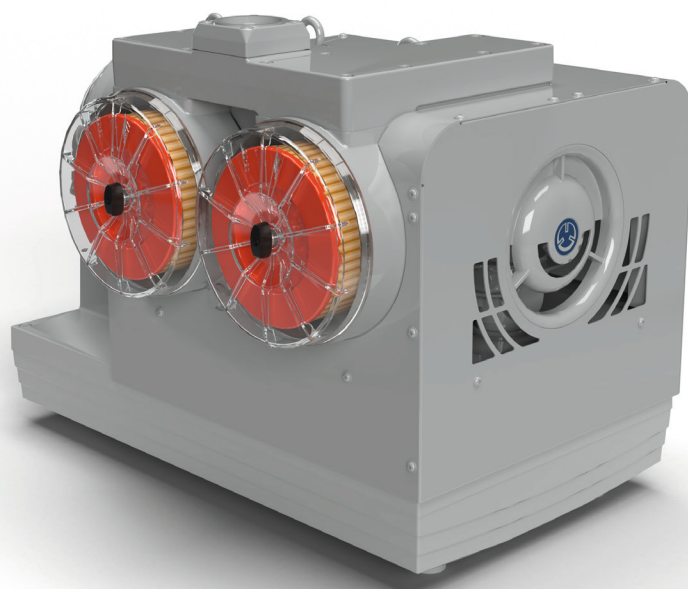

INDEX/INDICE

INDEX

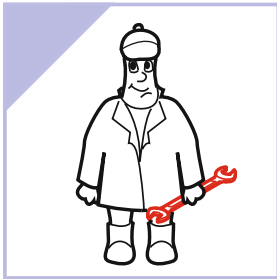

BECKER
 D-42279 Wuppertal
 www.becker-international.com

year **XXXX**

No **A XXXX**

CE type **XX.**

frequency **XXXX** /z

speed **XXXX** min⁻¹

power required **XXXX** kW

inlet capacity **XXXX** m³/h

pressure + **XXXX** mbar

vacuum - **XXXX** mbar

Made in Germany

INDEX



WWW.BECKER-INTERNATIONAL-SHOP.COM



wichtige Komponenten - Serviceteile
important components - Service Parts
composants importants - Pièces de service
importanti componenti - Parti di servizio
componentes importantes - Partes de servicio





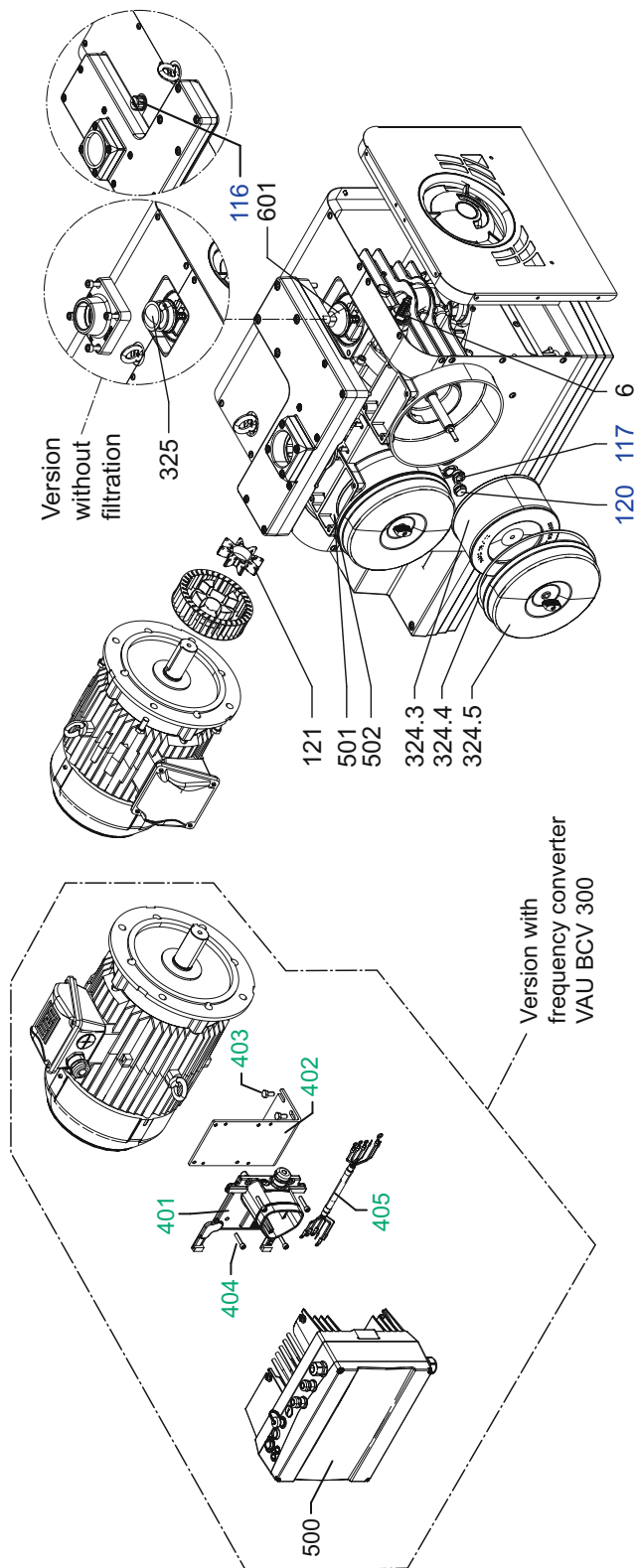

INDEX	Pos.	Ident No.	Description	Quantity
		960036 00101	BECKER LUBE G150 (SYNTHETIC OIL) ¹⁾	1 l
		960036 00201		5 l
	324.3	909500 65200	FILTER CARTRIDGE (PAPER)	2
		909501 65200	FILTER CARTRIDGE (POLYESTER)	2

¹⁾ FILLING CAPACITY BCV 300 = 1.00 L (MAX.)

BCV 300



INDEX	Pos.	Bestell Nr.	Beschreibung	
	K1	566100 65200	ÖLSCHAUGLASSSATZ	1)
	K2	596302 52915	ADAPTER-BAUGRUPPE	2)
	6	733702 99580	SICHERHEITSENTIL	
	116	K1	SCHRAUBDECKEL	
	117	K1	ÖLSCHAUGLAS	
	120	K1	ÖLABLASSSCHRAUBE	
	121	902212 00000	KUPPLUNGSSCHEIBE	
	324.3	909500 65200	FILTER (PAPIER)	
	324.3	909501 65200	FILTER (POLYESTER)	
	324.4	008900 65200	DICHTUNG	
	324.5	040200 65200	FILTERDECKEL	
	325	008000 65300	SIEB (FÜR VERSION OHNE FILTERUNG ERFORDERLICH)	
	401	K2	ADAPTERPLATTE	
	402	K2	WINKELBLECH	
	403	K2	SECHSKANTSCHRAUBE - M8X16	
	404	K2	INNENSECHSKANTSCHRAUBE - M6X30	
	405	K2	ANSCHLUSSKABEL	
	500	507501 65300	FREQUENZUMRICHTER-BAUGRUPPE	
	501	769302 42090	MESSUMFORMER 0-1 BAR	
	502	7420132 0300	SENSORANSCHLUSSKABEL	
	601	537500 65300	RÜCKSCHLAGVENTIL, KOMPLETT	
		960036 00101	ÖLGEBINDE 1 LITER (BECKER LUBE G 150)	
		960036 00201	ÖLGEBINDE 5 LITER (BECKER LUBE G 150)	
	1)	K1 - 566100 65200 → POS.: 116, 117, 120		
	2)	K2 - 596302 52915 → POS.: 401, 402, 403, 404, 405		

INDEX	Pos.	Ident No.	Description	
	K1	566100 65200	OILSIGHT GLASS KIT	1)
	K2	596302 52915	ADAPTER ASSEMBLY	2)
	6	733702 99580	RELIEF VALVE	
	116	K1	SCREW CAP	
	117	K1	OIL SIGHT GLASS	
	120	K1	OIL DRAIN PLUG	
	121	902212 00000	COUPLING DISC	
	324.3	909500 65200	FILTER (PAPER)	
	324.3	909501 65200	FILTER (POLYESTER)	
	324.4	008900 65200	GASKET	
	324.5	040200 65200	FILTER COVER	
	325	008000 65300	SIEVE (MANDATORY FOR VERSION WITHOUT FILTERING)	
	401	K2	ADAPTER PLATE	
	402	K2	ANGULAR SHEET	
	403	K2	HEX HEAD SCREW - M8X16	
	404	K2	SOCKET HEAD SCREW - M6X30	
	405	K2	CONNECTION CABLE	
	500	507501 65300	FREQUENCY CONVERTER ASSEMBLY	
	501	769302 42090	MEASUREMENT CONVERTER 0-1 BAR	
	502	7420132 0300	SENSOR CONNECTION CABLE	
	601	537500 65300	NON RETURN VALVE, COMPLETE	
		960036 00101	OIL CANISTER 1 LITER (BECKER LUBE G 150)	
		960036 00201	OIL CANISTER 5 LITER (BECKER LUBE G 150)	
	1)	K1 - 566100 65200 → POS.: 116, 117, 120		
	2)	K2 - 596302 52915 → POS.: 401, 402, 403, 404, 405		

INDEX	Pos.	No. d'identification	Designation	
	K1	566100 65200	ENSEMBLE DE VOYANT D'HUILE	1)
	K2	596302 52915	ENSEMBLE ADAPTATEUR	2)
	6	733702 99580	SOUPAPE DE SÉCURITÉ	
	116	K1	COUVERCLE À VIS	
	117	K1	JAUGE D'HUILE	
	120	K1	BOUCHON DE VIDANGE D'HUILE	
	121	902212 00000	DISQUE D'ACCOUPLMENT	
	324.3	909500 65200	FILTRE (PAPIER)	
	324.3	909501 65200	FILTRE (POLYESTER)	
	324.4	008900 65200	JOINT	
	324.5	040200 65200	COUVERCLE DE FILTRE	
	325	008000 65300	TAMIS (OBLIGATOIRE POUR LA VERSION SANS FILTRATION)	
	401	K2	PLAQUE D'ADAPTATION	
	402	K2	TÔLE ANGULAIRE	
	403	K2	VIS HEXAGONALE - M8X16	
	404	K2	VIS ALLEN - M6X30	
	405	K2	CÂBLE DE RACCORDEMENT	
	500	507501 65300	ENSEMBLE CONVERTISSEUR DE FRÉQUENCE	
	501	769302 42090	CONVERTISSEUR DE MESURE 0-1 BAR	
	502	7420132 0300	CÂBLE DE CONNEXION DU CAPTEUR	
	601	537500 65300	SOUPAPE DE RETENUE, COMPLET	
		960036 00101	CONTENEUR D'HUILE 1 LITRE (BECKER LUBE G 150)	
		960036 00201	CONTENEUR D'HUILE 5 LITRE (BECKER LUBE G 150)	

1) **K1 - 566100 65200** → POS.: 116, 117, 120

2) **K2 - 596302 52915** → POS.: 401, 402, 403, 404, 405

INDEX	Pos.	No. identificazione	Designazione	
	K1	566100 65200	KIT DI SPIA LIVELLO OLIO	1)
	K2	596302 52915	ASSEMBLAGGIO DELL'ADATTATORE	2)
	6	733702 99580	VALVOLA DI SICUREZZA	
	116	K1	COPERCHIO A VITE	
	117	K1	SPIA LIVELLO OLIO	
	120	K1	TAPPO DI SCARICO DELL'OLIO	
	121	902212 00000	DISCO GIUNTO	
	324.3	909500 65200	FILTRO (CARTA)	
	324.3	909501 65200	FILTRO (POLIESTERE)	
	324.4	008900 65200	GUARNIZIONE	
	324.5	040200 65200	COPERCHIO DEL FILTRO	
	325	008000 65300	CRIVELLO (OBBLIGATORIO PER VERSIONE SENZA FILTRAZIONE)	
	401	K2	PIASTRA DI ADATTAMENTO	
	402	K2	LAMIERA ANGOLARE	
	403	K2	VITE ESAGONALE - M8X16	
	404	K2	VITE A BRUGOLA - M6X30	
	405	K2	CAVO DI ALLACCIAMENTO	
	500	507501 65300	ASSEMBLAGGIO DEL CONVERTITORE DI FREQUENZA	
	501	769302 42090	CONVERTITORE DI MISURA 0-1 BAR	
	502	7420132 0300	CAVO DI COLLEGAMENTO DEL SENSORE	
	601	537500 65300	VALVOLA DI RITENUTA, COMPLETO	
		960036 00101	CONTENITORE DELL'OLIO 1 LITRO (BECKER LUBE G 150)	
		960036 00201	CONTENITORE DELL'OLIO 5 LITRO (BECKER LUBE G 150)	

1) **K1 - 566100 65200** → POS.: 116, 117, 120

2) **K2 - 596302 52915** → POS.: 401, 402, 403, 404, 405

INDEX	Pos.	No. de pedido	Descripción	
	K1	566100 65200	KIT DE MIRILLA DE ACEITE	1)
	K2	596302 52915	CONJUNTO ADAPTADOR	2)
	6	733702 99580	VÁLVULA DE SEGURIDAD	
	116	K1	TAPA DE ROSCA	
	117	K1	CRISTAL MIRILLA DE ACEITE	
	120	K1	TAPÓN DE DRENAJE DE ACEITE	
	121	902212 00000	DISCO DE ACOPLAMIENTO	
	324.3	909500 65200	FILTRO (PAPEL)	
	324.3	909501 65200	FILTRO (POLIÉSTER)	
	324.4	008900 65200	JUNTA	
	324.5	040200 65200	TAPA DE FILTRO	
	325	008000 65300	CRIBA (OBLIGATORIO PARA LA VERSIÓN SIN FILTRACIÓN)	
	401	K2	PLACA ADAPTADORA	
	402	K2	PLACA DE ÁNGULO	
	403	K2	TORNILLO DE CABEZA HEXAGONAL - M8X16	
	404	K2	TORNILLO CON HEMBRA HEXAGONAL - M6X30	
	405	K2	CABLE DE CONEXIÓN	
	500	507501 65300	CONJUNTO CONVERTIDOR DE FRECUENCIA	
	501	769302 42090	CONVERTIDOR DE MEDIDA 0-1 BAR	
	502	7420132 0300	CABLE DE CONEXIÓN DEL SENSOR	
	601	537500 65300	VÁLVULA DE RETENCIÓN, COMPLETO	
		960036 00101	CONTENEDOR DE ACEITE 1 LITRO (BECKER LUBE G 150)	
		960036 00201	CONTENEDOR DE ACEITE 5 LITRO (BECKER LUBE G 150)	
	1)	K1 - 566100 65200 → POS.: 116, 117, 120		
	2)	K2 - 596302 52915 → POS.: 401, 402, 403, 404, 405		



28000065300 | 2020-06-08 | All rights reserved

MAKE IT BECKER